

# CDR 100 Quick Installation Guide

**Copyrights & Trademarks**

**Safety Instructions**

**Setup**

**Appendix**

**Agency Approvals**

This Quick Installation Guide is a part of the  
CDR 100 User Manual.

For more detailed information see the User  
Manual on the CD which is delivered with the  
CDR 100 jukebox.







## Copyrights and Trademarks

### Notice of Copyright

All rights reserved. Copyright © 2001 by DISC GmbH. No part of this publication may be reproduced, stored in a retrieval system, or transmitted, in any form or by any means, electronic, mechanical, photocopying, recording, or otherwise, without the prior written consent of **DISC GmbH, 55411 Bingen, Im Tiergarten 20-30, Germany.**

### Disclaimer

DISC (DISC GmbH and all of its subsidiaries) takes no responsibility or warranty with respect of the adequacy of this documentation or the procedures which it describes for any particular purpose or with respect to its adequacy to produce any particular result. In no event shall DISC, its employees, its contractors or the authors of this documentation be liable for special, direct, indirect or consequential damages, losses, costs, charges, claims, demands, or claim for lost profits, fees or expenses of any nature or kind.

### Changes

The material in this specification is for information only and is subject to change without notice. While reasonable efforts have been taken in the preparation of this manual to assure its accuracy, DISC GmbH assumes no liability resulting from any errors or omissions in this manual, or from the use of the information contained herein.

DISC GmbH reserves the right to make changes in the product design without reservation and without notification to its users.



**Trademarks Used in this Manual**

Additional Information may be obtained from:

**DISC GmbH**  
**55411 Bingen am Rhein**  
**Im Tiergarten 20-30**  
**Germany**

**Trademarks Used in this Manual**

DISC Logo is a registered trademark of DISC GmbH

Kap.0.fm/ 07.02.1997/06.08.2001

## Safety instructions

- Intended use
- Residual risks
- Safety

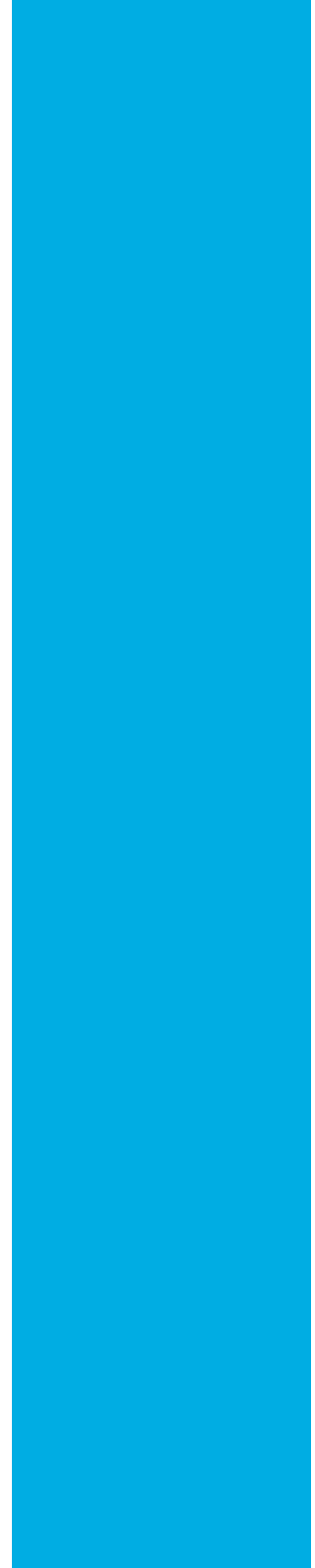





# 1 Safety instructions

## Intended use

The CDR 100 jukebox is controlled by a host computer and contains state of the art and very reliable technology. The CDR 100 jukebox was exclusively designed to read CD's and is capable of recording CD's if equipped with a recorder drive. The jukebox is not intended for any other use.

Improper use of the CDR 100 jukebox may cause residual risks if it is used or operated by unauthorized individuals. Any person who uses the CDR 100 jukebox should read and understand the user's manual and specially the safety instructions.

## Residual risks

In this Quick Installation Guide residual risks are marked as follows:



### Warning!

Disregarding the safety messages following „Warning!“ can cause material damage (damage of parts).



### Danger!

Disregarding the safety messages following „Danger!“ can cause personal damage.

## Ban of arbitrary reversion and changes

The CDR 100 jukebox may not be altered due to applicable safety regulations.

## Repairs

Repairs must be carried out by DISC service staff, or by qualified and authorized service staff. DISC GmbH will not be liable for any damages caused by alterations or repair by unauthorized individuals.



### Warning! Set-up

Before you connect this unit to the mains, please check your local mains voltage and compare it with the setting of the unit. If your local mains voltage does not correspond to the

## Safety instructions

mains voltage setting of the unit you must not set-up the unit.

Replace fuses only with same type and value!



### **Warning! Fire damages**

To reduce fire or shock hazard, do not expose this unit to rain or moisture.



### **Warning! Opening the unit**

To prevent electrical shock, remove line cord before opening this unit!



### **Danger!**

Disassembling parts and changing of any adjustment, apart from those described in this manual, may result in exposure to hazardous laser radiation!

### **Safety**

This product is a Laser Class 1 device. Disk access is carried out by using a laser beam. The laser does not represent any risk for the user.

This product complies with the DHHS Rules 21 CFR chapter 1, subchapter J, applicable at the date of manufacturing. Accession number 9520184





## Setup

- Jukebox setup
- What to do first?
- Setting the switches and jumpers
- Connecting to a host computer
- Connecting to an audio amplifier
- Connecting line voltage

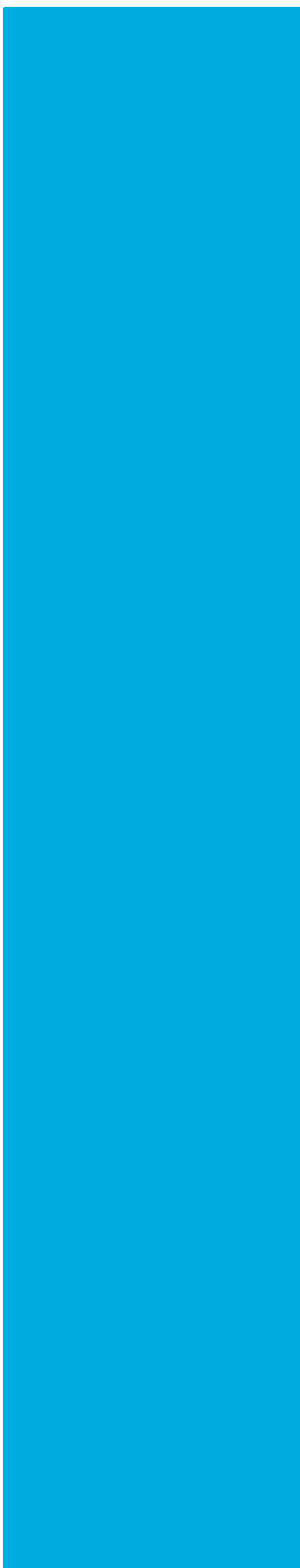

## 2 Setup

In this chapter you will find all information being necessary to activate the CDR 100 jukebox.



**Warning:**

Remove all transportation fixtures before powering on the CDR 100. Otherwise the unit might be damaged.

### 2.1 Jukebox setup

For the setup of the CDR 100 perform the following steps. Details of the single steps are described in the following sections.

**What to do at first?**

- Check if the delivery is complete;
- Place the unit;
- Remove all transportation fixtures;

**Setting the ID's**

- Setting the RS232-ID;
- Setting the SCSI-ID;

**Connecting to a host computer and mains voltage**

- Connecting RS232 robotics interface;
- Connecting SCSI interface;
- Connecting line cord;
- Power-on;

## 2.2 What to do first?

### 2.2.1 Checking the delivery

Unpack the unit and check if the delivery is complete:



**Note:**

Store the shipping carton and the packaging material for a possible later transport. Thus you can transport your unit safely.

Delivery	
Power Cord	3
Serial cable	1
SCSI terminator	1
Fuses	3
Lamps	2
Keys	2
Manual CD	1
CDR 100 jukebox	1

Please check whether the delivery is complete. If any parts are missing please inform your supplier.

### 2.2.2 Placing the jukebox

The CDR 100 jukebox is intended to be used in offices.



**Note:**

After delivery the temperature of the CDR 100 should be adapted slowly to the room temperature.

**Avoid places with:**

- extreme temperatures or excessive sun exposure
- high humidity
- contact with water and chemicals
- extreme vibrations

- The right location:**
- has a stable, even support
  - has sufficient space to pull out the unit

### 2.2.3 Removing the transportation fixtures



**Warning!**

The unit must be switched on only when the transportation fixtures have been removed.



**Note:**

Store the transportation fixtures in a safe place. Insert them always in the unit before any transportation.

**Steps**

- Insert the key and turn it to the „unlocked“ position.
- Open the front door.
- Remove the paper transportation fixture between the magazines.
- Remove the red plastic splint mounted to the lift shaft in the back of the jukebox.
- Press the buttons above the magazines to the center of the jukebox and turn out the magazines.
- Remove the four metal clamps mounted to each magazine.
- To remove a magazine from the jukebox press the button above the magazine to the center of the jukebox and turn out the magazine. When the magazine is turned out, press the button to the other direction and remove the magazine.

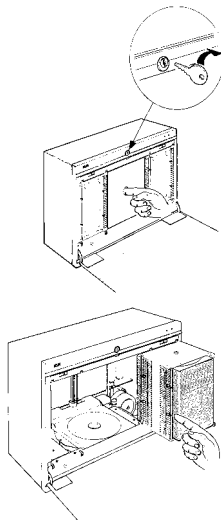

Kap2.fm / 03.06.1998/06.08.2001

### 2.3 Setting the switches and jumpers

To change to ID setting of the SCSI interface and the RS232 interface of the CDR 100 jukebox open the front door and remove the right magazine.

Locate the interface board at the right side of the inner back plane of the CDR 100 unit. To select a new ID number use a small screw driver. Set the desired ID number by turning the arrow of the switch (switch S1 = serial ID; switch S2 = SCSI ID) to the position with the number that represents the ID number.

NSM Storage recommends to use the same ID number for the RS232 and the SCSI interface.

In case of cascading more than one CDR 100 by daisy chain, it is important to take care that all units are set to the same baud rate (see chapter 2.4).

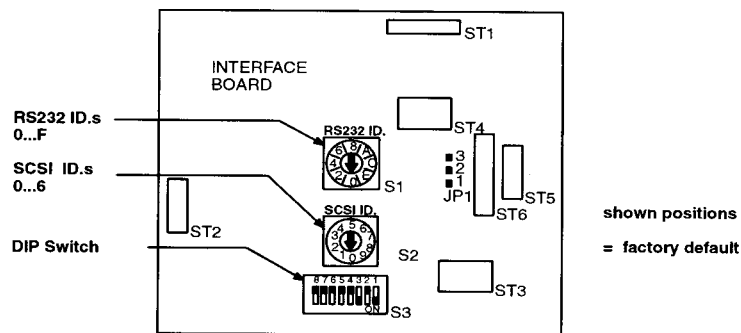

The DIP switch S3 and the jumper JP1 can be used to select the baudrate of the serial interface, data parity for the SCSI bus and Termination power.



The setting of the DIP switch S3 and the jumper JP1 depends on the type of installed drive.



### 2.3.1 Settings for Toshiba XM 3501 B drive

Table 1

Switch S3	Function	ON	OFF
1	Data parity	disabled	enabled
2	Not used		
3	Factory use only		
4	Factory use only		
5	Baudrate setting	refer to	table 2
6	Baudrate setting	refer to	table 2
7	Not used		
8	Factory use only		

Table 2

Baudrate	DIP 5	DIP 6
1200	OFF	ON
9600	OFF	OFF
19200	ON	OFF

#### Jumper JP1

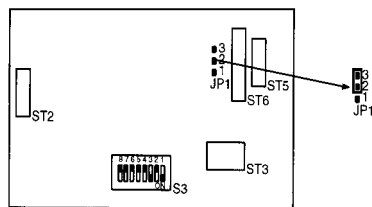

Position 1-2 = Termination power OFF

Position 2-3 = Termination power ON

Kap2.fm / 03.06.1999/06.08.2001

## Setup

### Setting the switches and jumpers

#### 2.3.2 Settings for Yamaha CDR 100 drive

Table 3

Switch S3	Function	ON	OFF
1	Data parity	disabled	enabled
2	Not used		
3	Factory use only		
4	Factory use only		
5	Baudrate setting	refer to	table 4
6	Baudrate setting	refer to	table 4
7	Not used		
8	Factory use only		

Table 4

Baudrate	DIP 5	DIP 6
1200	OFF	ON
9600	OFF	OFF
19200	ON	OFF

#### Jumper JP1

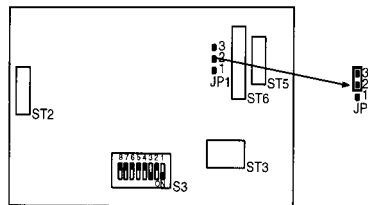

Position 1-2 = Termination power OFF

Position 2-3 = Termination power ON





### 2.3.3 Settings for TEAC CD-516S drive

Table 5

Switch S3	Function	ON	OFF
1	Data parity	disabled	enabled
2	Must always be ON		
3	Blocksize	512 Byte	2048 Byte
4	Factory use only		
5	Baudrate setting	refer to	table 6
6	Baudrate setting	refer to	table 6
7	Not used		
8	Factory use only		

Table 6

Baudrate	DIP 5	DIP 6
1200	OFF	ON
9600	OFF	OFF
19200	ON	OFF

#### Jumper JP1

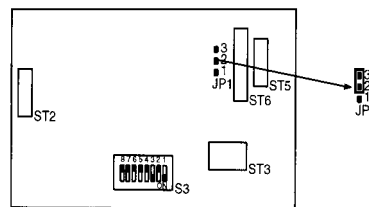

Jumper JP1 must be removed for operating the jukebox with a TEAC CD-516S CD ROM drive.

Kap2.fm/ 03.06.1999/06.08.2001

## Setup

### Setting the switches and jumpers

#### 2.3.4 Settings for Plextor PX-R412 drive

Table 5

Switch S3	Function	ON	OFF
1	Data parity	enabled	disabled
2	Must always be OFF		
3	Not used		
4	Blocksize	512 Byte	2048 Byte
5	Baudrate setting	refer to	table 6
6	Baudrate setting	refer to	table 6
7	Not used		
8	Factory use only		

Table 6

Baudrate	DIP 5	DIP 6
1200	OFF	ON
9600	OFF	OFF
19200	ON	OFF

#### Jumper JP1

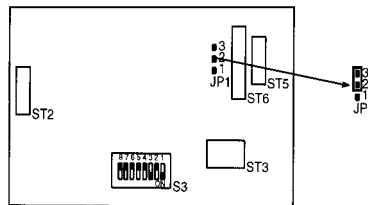

Jumper JP1 must be removed for operating the jukebox with a Plextor PX-R412 recorder drive.

### 2.3.5 Settings for Toshiba SD-W1101 DVD drive

Table 6

Switch S3	Function	ON	OFF
1	Not used		
2	Verify	enabled	disabled
3	one lun / two lun	two lun	one lun
4	Blocksize	512 Byte	2048 Byte
5	Baudrate setting	refer to	table 6
6	Baudrate setting	refer to	table 6
7	Not used		
8	Factory use only		

Table 6

Baudrate	DIP 5	DIP 6
1200	OFF	ON
9600	OFF	OFF
19200	ON	OFF

#### Jumper JP1

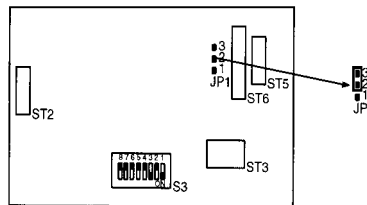

Jumper JP1 must be removed for operating the jukebox with a Toshiba SD-W1101 DVD drive.

## Setup

### Connecting to a host computer

#### 2.4 Connecting to a host computer



Before you connect the CDR 100 to your host system, please make sure to switch off the power supply of the CDR 100 and the host.

Use the supplied RS232 cable to connect the 9 pin D-Sub connector of the jukebox marked as **RS232 IN** to the serial interface of your host computer.

Use a SCSI cable with 50 pin male Delta Ribbon connector to connect the SCSI interface of the CDR 100 jukebox to the SCSI host adapter of your host computer.

If the CDR 100 jukebox is the last device on your SCSI bus, the SCSI bus has to be terminated at the jukebox. To terminate the SCSI bus connect the supplied external SCSI terminator to the second connector of the SCSI interface at the backside of the jukebox.

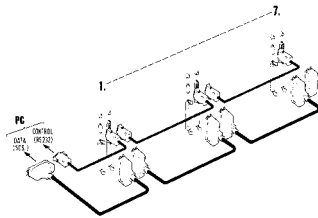
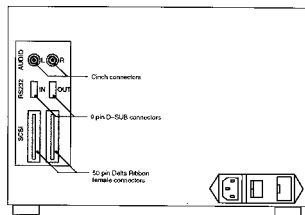

#### Please note the following information:

If you operate a CDR 100 jukebox with Teac CD-516S CD ROM drive, the parameter „**Plug& Play supporting** the BIOS of the SCSI host adapter has to be **disabled**, otherwise the SCSI host adapter might set the drive to another SCSI ID without taking care of the SCSI ID set with switch **S2** inside the jukebox.

If more than one CDR 100 jukebox should be connected via the serial bus to the host computer each jukebox needs an unique RS232 ID on the serial bus. The complete cable length of the serial cable should not be longer than 15 m.

If more than one CDR 100 jukeboxes should be connected to the same SCSI bus it is important to take care of the cable length:

**asynchronous data transfer 6 m**

**synchronous data transfer 3 m**



The cable length of the SCSI bus inside the CDR 100 jukebox is 80 cm.

## 2.5 Connecting to an audio amplifier

The cinch connectors at the back of the jukebox can be used to connect the CDR 100 jukebox to any audio amplifier using a standard audio cable.

Make sure the CDR 100 jukebox and the audio amplifier are switched off before you connect the audio interface.

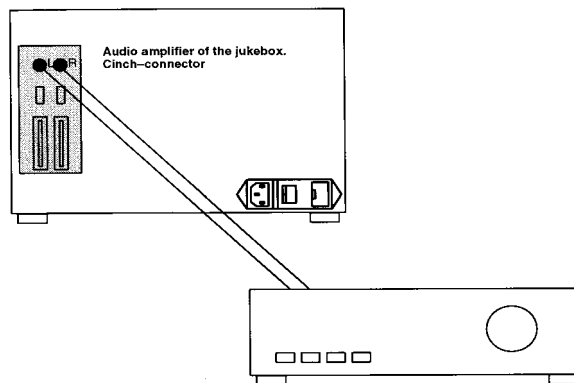

## 2.6 Connecting line voltage

Before you connect the CDR 100 jukebox to line voltage, check if the voltage setting of the jukebox fits to the line voltage of your country.

If the voltage setting of the jukebox is not correct, change the voltage setting by opening the voltage selector at the back side of the jukebox and turn it to the desired voltage (120V or 230V).

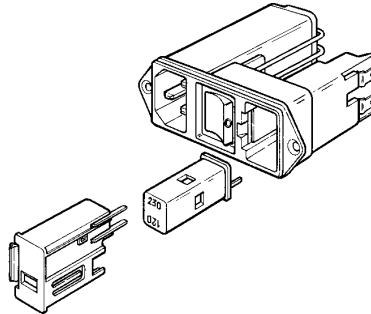

## Appendix

- Technical data

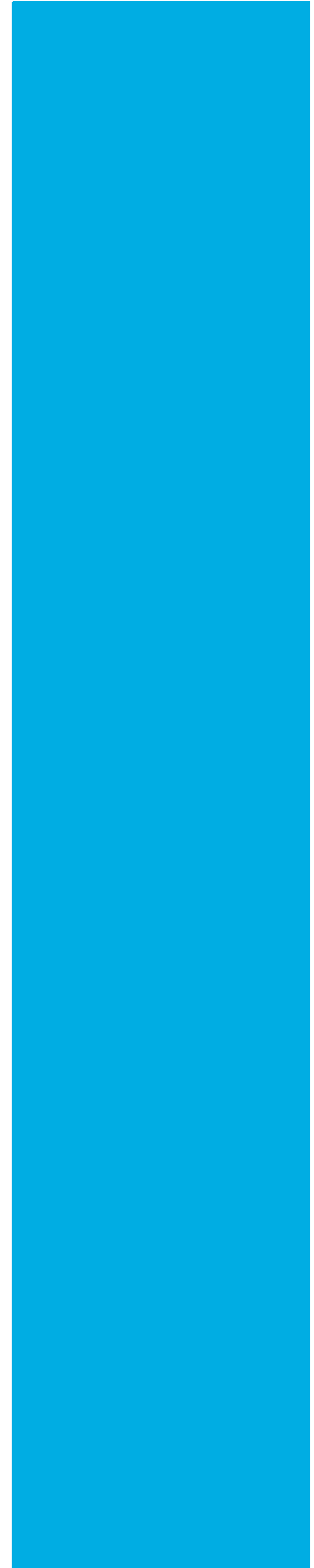





## 3 Appendix

### 3.1 Technical data

<b>Factory settings</b>		
RS232-ID	0	
Baud rate	9600 Baud	
Number of start bits	1	
Number of data bits	8	
Number of stop bits	1	
Parity check	no parity	
SCSI-ID	0	
<b>Operating conditions</b>		
Ambient temperature		
Operating	10°C – 37°C	50°F – 98,6°F
Gradient of temperature	11°C/h	19,8°F/h
Relative humidity operating	10 % – 75 %	non condensing
<b>Power supply</b>		
Line voltage	230 V / 120 V	AC ± 15 %
Frequency range	50 / 60 Hz	
Power consumption normal	20 W	
Power consumption max.	50 W	
<b>Dimension and Weight</b>		
Width	472 mm	
Height	365 mm	
Depth	215 mm	
Weight	18 kg	

Kap3.fm/ 31.01.1997/06.08.2001

**3**

**Appendix**  
Technical data

Kap.3.fm/ 31.01.1997/06.08.2001

## Agency Approvals

- FCC declaration
- Declaration of conformity

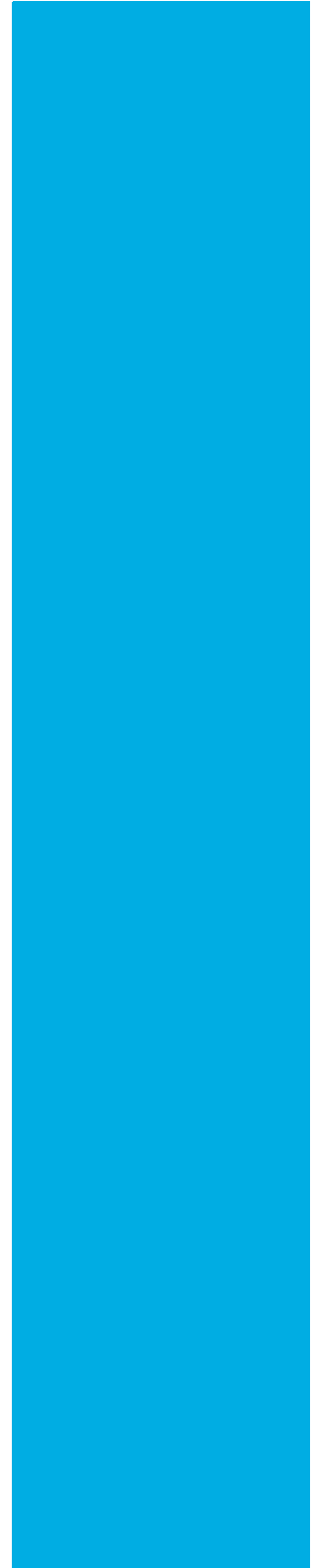



## 4 Agency Approvals

### 4.1 FCC declaration

This equipment has been tested and found to comply with the limits for a Class B digital device, pursuant to Part 15 of the FCC Rules. These limits are designed to provide reasonable protection against harmful interference in a residential installation. This equipment generates, uses, and can radiate radio frequency energy and, if not installed and used in accordance with the instructions, may cause harmful interference to radio communications. However, there is no guarantee that interference will not occur in a particular installation. If this equipment does cause harmful interference to radio or television reception, which can be determined by turning the equipment on and off, the user is encouraged to try to correct the interference by one or more of the following measures:

- Reorient or relocate the receiving antenna.
- Increase the separation between the equipment and receiver.
- Connect the equipment into an outlet on a circuit different from that to which the receiver is connected.
- Consult the dealer or an experienced radio/TV technician for help.

**Important:** This product was FCC verified under test conditions that include use of shielded cables and connectors between system components. It is important that you use shielded cables and connectors to reduce the possibility of causing interference to radios, TV sets, and other electronic devices.

Should you have any problems contact your dealer.

Any change or modifications to the equipment by the user not expressly approved by the grantee or manufacturer could void the user's authority to operate such equipment.

## Agency Approvals

### Declaration of conformity

#### 4.2 Declaration of conformity



EG-KONFORMITÄTSERKLÄRUNG mit der Richtlinien 89 / 336 / EWG und 73 / 23 / EWG.	EC-DECLARATION OF CONFORMITY per 89/ 336 / EEC, and 73 / 23 / EWG.	CE-DECLARATION DE CONFORMITE avec 89/ 336 / CEE et 73 / 23 / EWG.
Hiermit wird bestätigt, daß das Produkt  CD-ROM Jukebox <b>CDR 100 XA</b>	This is to confirm that the product  CD-ROM Jukebox <b>CDR 100 XA</b>	Nous déclarons que le produit  Jukebox CD-ROM <b>CDR 100 XA</b>
mit den folgenden Normen bzw. normativen Dokumenten übereinstimmt:	is conform with the following standards or other normative documents:	est conforme aux normes ou autres documents normatifs suivants:
<b>EN 50081-1</b> , EN 550 22, <b>EN 61 000-3-2</b> , EN 61 000-3-3 <b>EN 50082-1</b> , IEC 801-2, IEC 801-3, IEC 801-4. <b>EN 60950</b> .	<b>EN 50081-1</b> , EN 550 22, <b>EN 61 000-3-2</b> , EN 61 000-3-3 <b>EN 50082-1</b> , IEC 801-2, IEC 801-3, IEC 801-4. <b>EN 60950</b> .	<b>EN 50081-1</b> , EN 550 22, <b>EN 61 000-3-2</b> , EN 61 000-3-3 <b>EN 50082-1</b> , IEC 801-2, IEC 801-3, IEC 801-4. <b>EN 60950</b> .
Das Qualitätssicherungssystem der NSM garantiert die Konformität.	NSM quality assurance system assures compliance.	Le système d'assurance de la qualité de NSM garantit la conformité.
<b>NSM Jukebox GmbH</b> Im Tiergarten 20-30 D-55411 Bingen am Rhein	<b>NSM Jukebox GmbH</b> Im Tiergarten 20-30 D-55411 Bingen am Rhein, Germany	<b>NSM Jukebox GmbH</b> Im Tiergarten 20-30 D-55411 Bingen am Rhein, Allemagne
Ausstellungsdatum: <b>07.03.1996</b>	Date of issue of the declaration: <b>03-07-1996</b>	Date d'établissement de la déclaration: <b>07.03.1995</b>

A. Frank

Geschäftsführer

P. Lober

Projektleiter



**Germany:**

**DISC GmbH  
Im Tiergarten 20-30  
D-55411 Bingen  
Phone: +49 (0)6721 964-430  
Fax: +49 (0)6721 964-414**











